

The Standard for Pathology Imaging

Helping pathology partners develop roadmaps

- Professional images from streamlined workflows
- Shared central image archive
- Secure telepathology interface
- Synchronized LIS connectivity

Based on the principles of:

- Practical, budget positive solutions that pay for themselves
- Integrated, stepwise implementation
- Fitting your existing infrastructure of equipment and software
- Solid performance 55+ years of problem-solving experience



SPOT Imaging Partner Sampling



QR to SPOT products



6540 Burroughs Avenue • Sterling Heights • MI • 48314-2133
 586.731.6000 • toll free (US) 1-866-604-SPOT • spotimaging.com • info@spotimaging.com

PS 8PG BRO_08.24



PathStation™ Telepathology and Image Archiving



SHARES GROSSING IMAGES DIRECTLY FROM THE FROZEN SECTION ROOM

PathStation™ | Fits your Lab

PathStation hood Compact In-hood Imaging system. Supports in-process documentation



PathStation Key Features

- 20 MP Image Capture
- Great HD Video
- 8.33X Optical zoom
4X Digital zoom
- 34" x 28" Max FoV
- 0.50" x 0.38" Min FoV
- Auto Calibration
- Small Package
- Supports Your Workstation
- Foot Pedal Camera Control
- Auto Focus
- Auto Exposure
- Bar Code Auto Login
- One-Click Archive
- One-Click Telepathology Connection
- Pathology Optimized Interface
- Easy Clean Design
- Washable Keyboard and Mouse



720p HD Video Telepathology

So Live it Seems Real!

Crisp, real time 720p HD video communicates the smallest details for discussion, ensuring an easy, effective workflow during image preview and telepathology.

20 Megapixel Image Capture

Stunning Image Detail!

20Mp image capture supports post acquisition cropping while maintaining the resolution necessary for publication. Additionally, the 20 Mp image capture easily exceeds the 10 Mp resolutions required for legal submissions.



PathStation™ | The Smart Choice

Easy to Implement

SPOT Imaging Solutions has developed turnkey solutions with configuration options to support your facility's unique hardware and software infrastructure. The result is an optimized work environment that is easily implemented into your existing infrastructure.



"The installation was quick and we were imaging the next day!"

Satisfied Pathology Assistant, Canada

We Support You!

You are never alone with PathSuite. InSpec™ technical service. Our 47 year tradition of standing behind our equipment ensures your uptime performance with on-line, on-phone or on-site assistance.



"We had a different system that was sitting in a box because we couldn't use it, PathSuite is so easy to use... Thanks SPOT Imaging!"

Medical Center, MI

Pathology Solutions to Support Your Team

Microscope Imaging

- Routine Anatomical Pathology
- Frozen Section Consults
- Needle Biopsy Consults
- Tumor Board Presentations
- Teaching and Training

Macro Imaging

- Routine Gross Dissection
- Frozen Section Consults
- Teaching and Training

G2 Dimensions

Camera Head

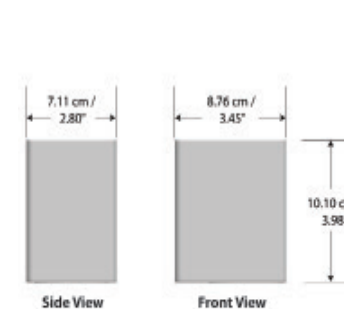

G20 Dimensions

Camera Head

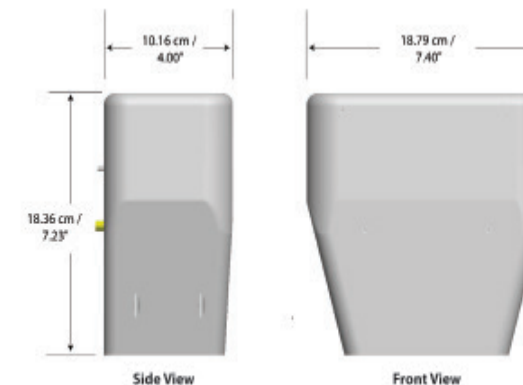

Control Box

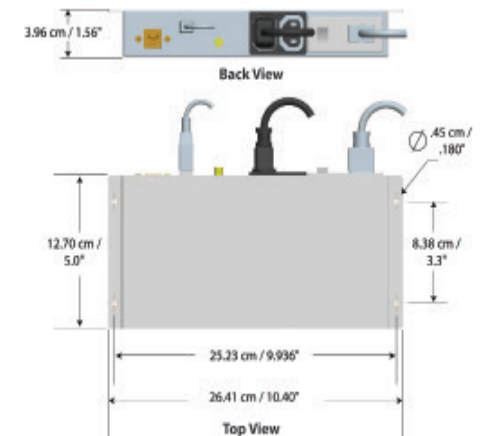

Return on Your Investment

Our install base has garnered dramatic time savings on image acquisition across multiple pathology work tasks resulting in impressively short ROI periods, followed by ongoing savings year after year.

SAVE TIME!

Routine Gross Dissection

Time Saved per Specimen		Specimens per Day		Time Saved per Day	or	Time Saved per Year
10 Min	x	12	=	2 Hrs		520 Hrs

Increase Consultations

Increasing intraoperative and needle biopsy adequacy consultations provides savings for the organization and the physician by eliminating unreimbursed secondary procedures and increasing patient satisfaction. Pathologists and Pathologist Assistants benefit from the increased efficiency of providing their consults virtually, avoiding the unproductive trip otherwise required.

Professional Documentation

Consistent documentation of your work provides the foundation for quality assurance and process improvement. It is also the basis of how you are perceived by your patients, referring physicians and by the legal establishment.

Fully integrated and completely scalable - integrating cameras, audio, barcode scanners and software. Our pathology imaging suite is designed to empower you from scanning to case sign-out.

Compact!

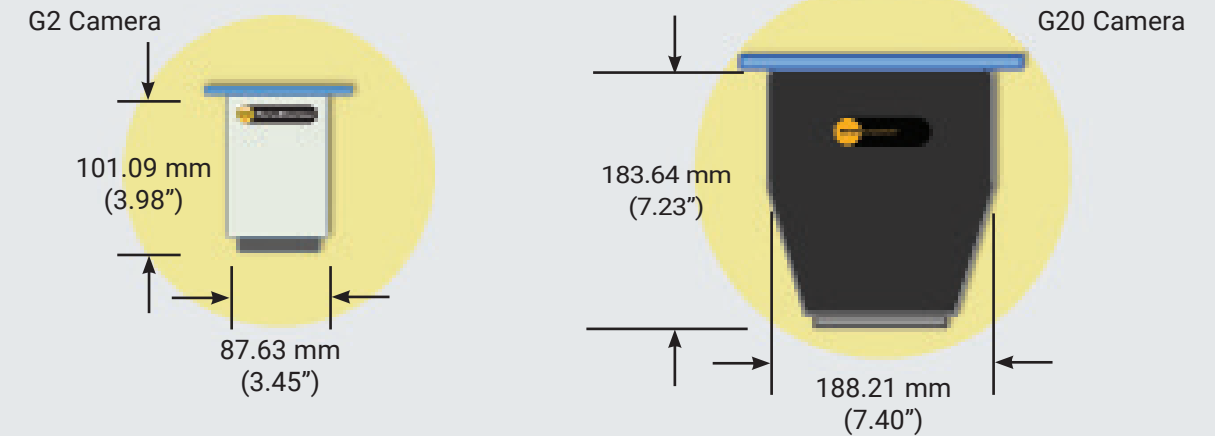

Optical Zoom

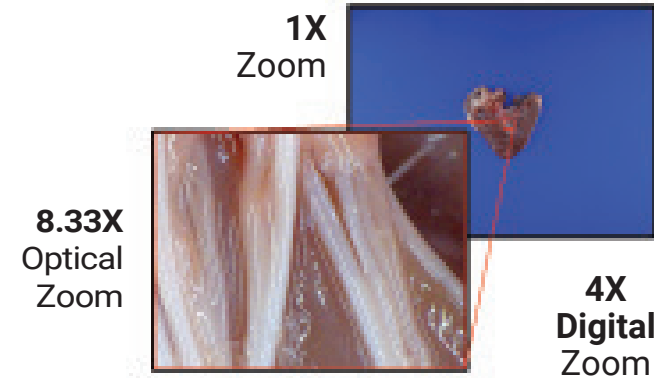

Hands Free Imaging



Camera Control



Automated Workflow Saves Time!

- Barcode Auto Login
- Auto Exposure
- Auto Focus
- Auto Archiving

High Resolution Touch Screen



Washable Keyboard and Mouse



PathStation™ | Easy-to-Learn, Easy-to-Use

PathSuite provides the user with a simple icon driven user interface with one click access to essential controls. This makes PathSuite intuitive to learn and a pleasure to use. PathSuite supports both gross and microscopy imaging with a common user interface.

Gross Imaging

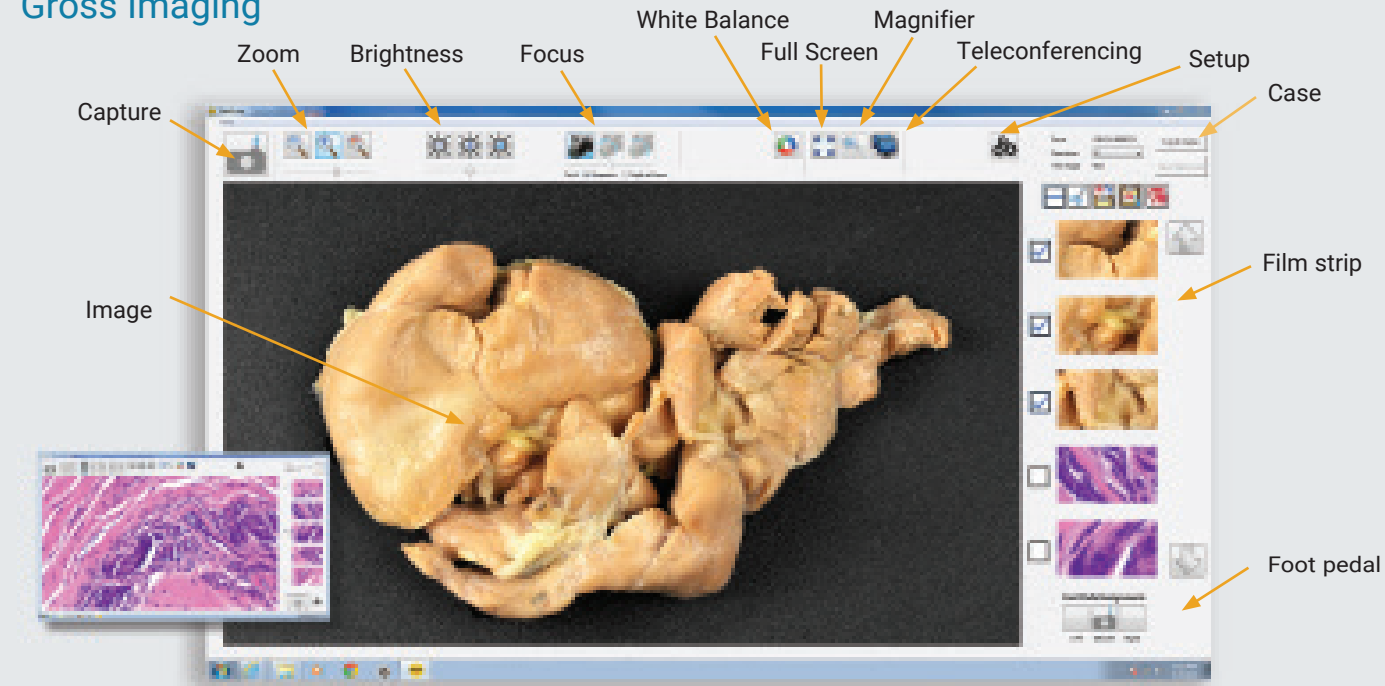

Streamline Workflow

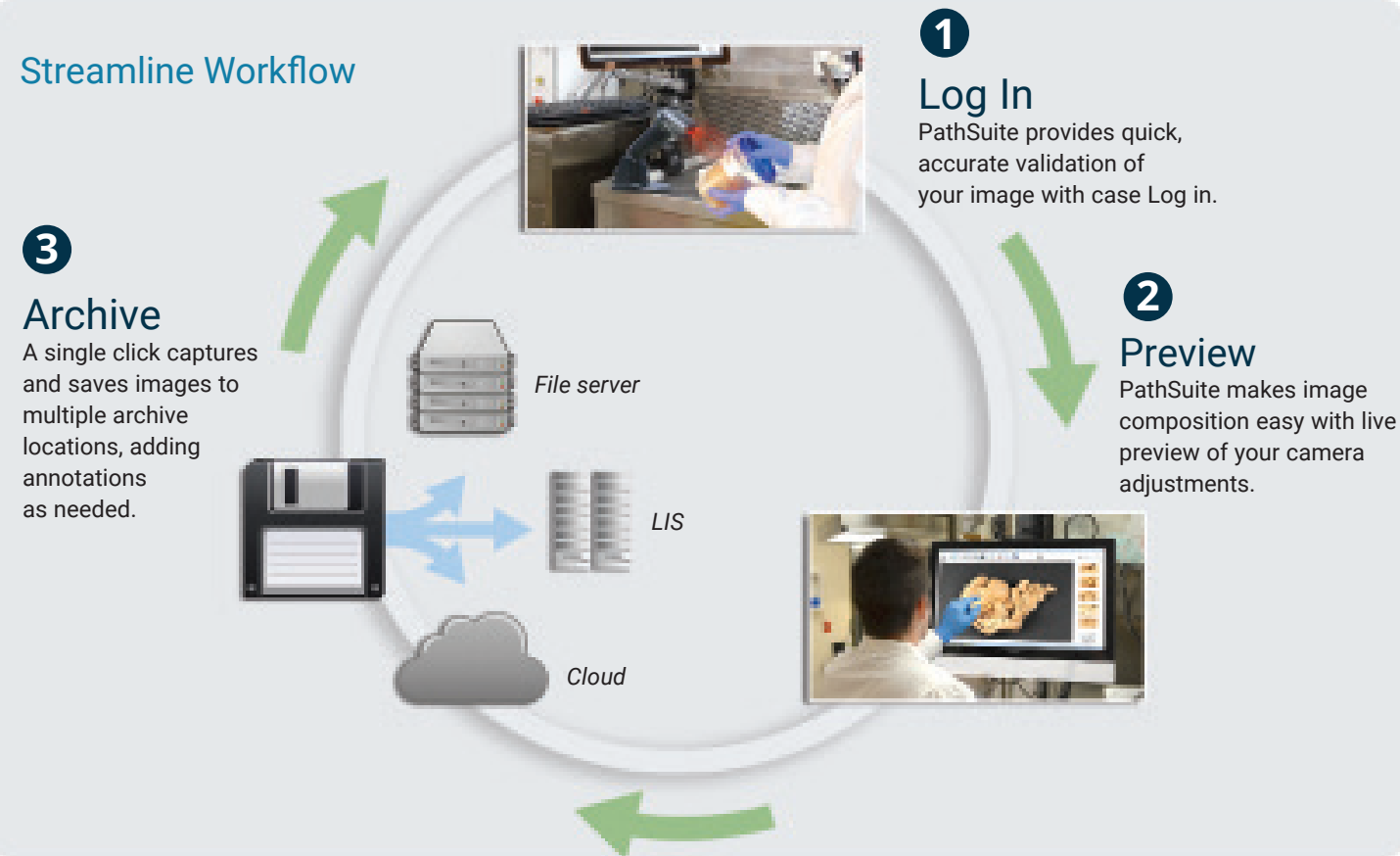

PathStation™ | Optimized Interface

Measurement and Annotate

PathSuite provides a full suite of annotation and measurement tools for detailing your images without transferring images between programs or computers.

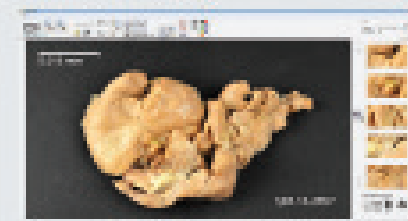

Auto Imprints

Imprint marks add a dimensional reference to your image.



Measurement

PathSuite's pre-calibrated images allow for easy measurement of length, area & angle.



Custom Annotations

A full set of text and drawing tools ensure you have the arrow text or oval to quickly and fully detail your images for consultation, publication or standard reporting.

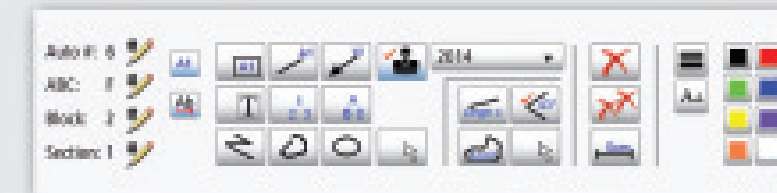

Style

Annotation style preferences are easily set or changed with control over numbering protocol, font, size, color, fill, etc...

Telepathology

PathSuite provides simple, secure connections and fully interactive live consults in a practical and affordable format.

Connect

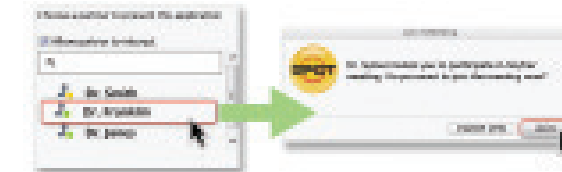

Colleague meetings are initiated by selecting the team member from the connection menu. The colleague receives an invitation prompt on their screen and joins the meeting with a simple click. Non-colleague attendees are easily added to meetings via e-mail invites. Once accepted, meetings are secured using guest passwords and data encryption, supporting HIPPA requirements.

Consult

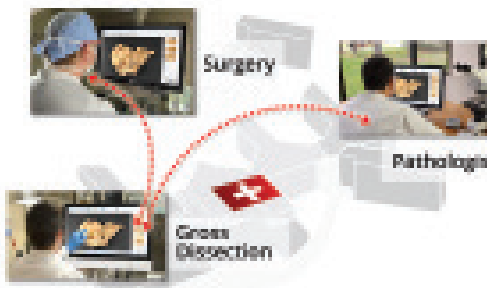

Discussion images are easily saved to the case with a click of a button preserving results for later reference and follow up.

Document

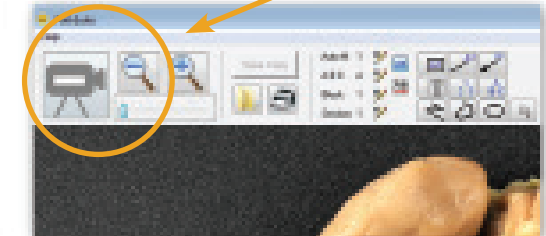

PathSuite ensures a rich collaborative consult allowing colleagues to easily clarify orientation, discuss dissection and verify margins.

Save Time

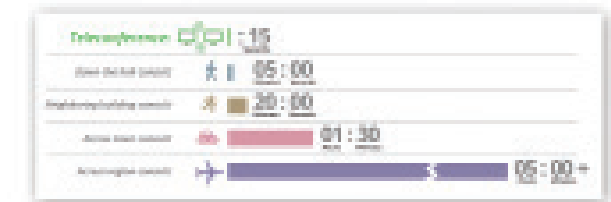

PathSuite telepathology solutions save you time on each trip you make whether it be down the hall, down the street or across the world. It eliminates the time and frustration associated with the trip and the unaccounted for impromptu interactions that occur with each trip. Telepathology lets you connect, consult and return to work without leaving your desk, it's that simple.